

Article number: 20477B10MT

Description: E+G Clamp mounting - GN 477-B10-MT

Measures

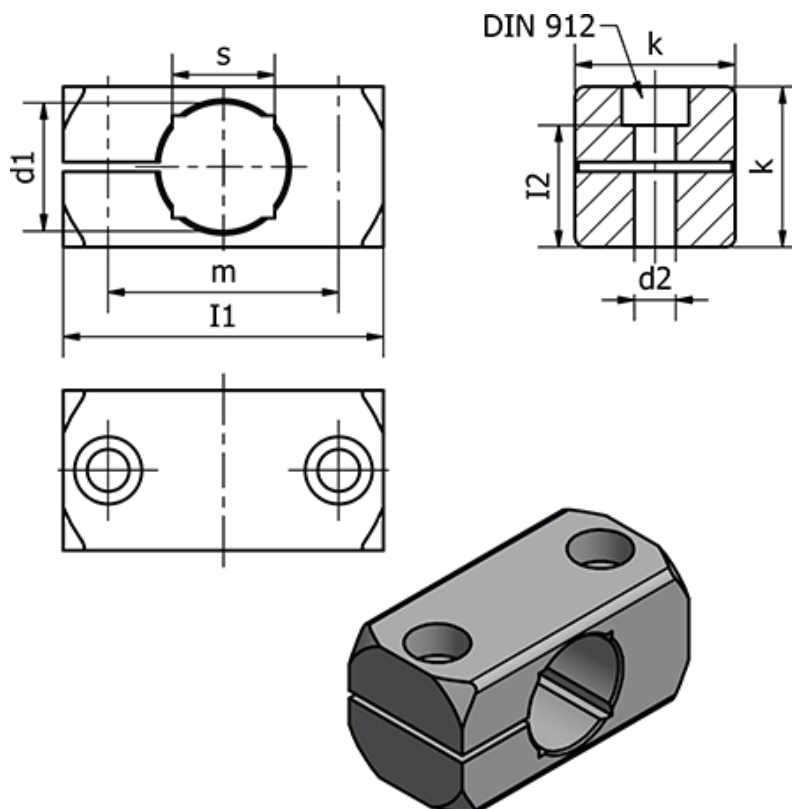

Clamping kit for d2 = GN 511-M5-25

Clamping kit for d3 = -

d1 = 10

d2 = M5

l1 = 38

l2 = 10.5

k = 16

m = 27

s = 8

Weight (g) = 18